

# Canalón Circular de 2 pestañas Uraplast

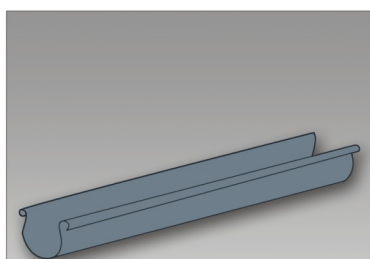

PERFIL CANALON

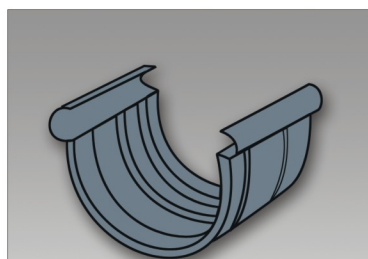

MANGUITO UNION

## PERFIL CANALON\*

REF.	DIAMETRO Ø mm
10XX1001	125
10XX1002	185
10171003	250

\* Se suministra en longitud de 4m.

## MANGUITO UNION

REF.	DIAMETRO Ø mm
10XX1004	125
10XX1005	185
10171006	250

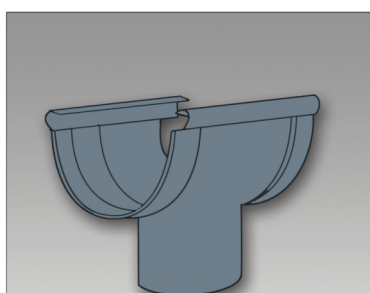

CONEXION BAJANTE

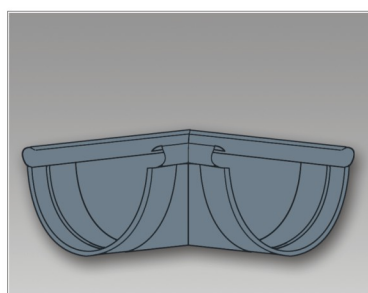

ESQUINA

## CONEXIÓN BAJANTE

REF.	DIAMETRO Ø mm
10XX1007	125
10XX1008	185
10171009	250

## ESQUINA

REF.	DIAMETRO Ø mm
10XX1010	125
10XX1011	185
10171012	250

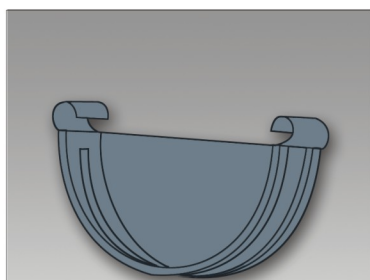

TAPON PARA CANALON

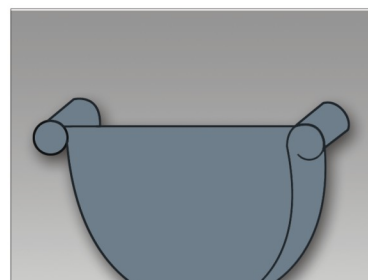

TAPON PARA PIEZA

## TAPON PARA CANALON

REF.	DIAMETRO Ø mm
10XX1013	125
10XX1014	185
10171015	250

## TAPON PARA PIEZA

REF.	DIAMETRO Ø mm
10XX1016	125
10XX1017	185
10171018	250

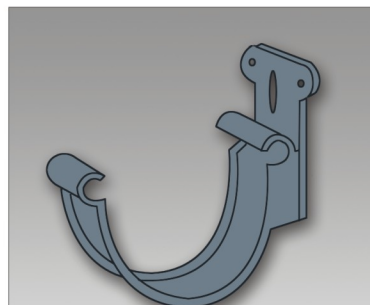

GAFA

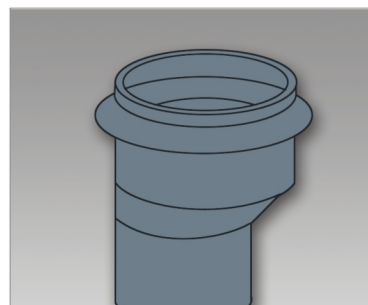

REDUCTOR JUNTA ELASTICA

## GAFA

REF.	DIAMETRO Ø mm
10XX1019	125
10XX1020	185
10171021	250

## REDUCTOR JUNTA ELASTICA

REF.	DIAMETRO Ø mm
10171022	90 - 75
10171023	110 - 90
10171024	125 - 110

XX= 17 GRIS URALITA Y XX= 18 GRIS EUROPEO